



150mA, Low-Dropout Linear Regulator with Power-OK Output

MAX8885

General Description

The MAX8885 low-dropout (LDO) linear regulator operates from a +2.5V to +6.5V input voltage range and delivers up to 150mA. It uses a P-channel MOSFET pass transistor to allow a low 85µA supply current—which is independent of the load—as well as LDO voltage. The MAX8885 is optimized to operate with low-cost, high-ESR output capacitors such as small case-size tantalum capacitors. It is ideal for cost-sensitive portable equipment such as PCS and cellular phones. For a pin-compatible, functionally equivalent device for use with a low-ESR, ceramic output capacitor, refer to the MAX8875 data sheet.

The MAX8885 features a power-OK output that indicates when the output is out of regulation, and is available in preset output voltage versions of 5.0V, 3.3V, 3.0V, 2.7V, and 2.5V. Other features include 1µA (max) shutdown current, short-circuit protection, thermal shutdown protection, and reverse-battery protection. The MAX8885 is available in a miniature 5-pin SOT23 package.

Applications

PCS Phones	Modems
Cellular Phones	Hand-Held Instruments
Cordless Phones	Palmtop Computers
PCMCIA Cards	Electronic Planners

Output Voltage Selector Guide

PART	V _{OUT} (V)	TOP MARK
MAX8885EUK25	2.5	ADLE
MAX8885EUK27	2.7	ADLF
MAX8885EUK30	3.0	ADLG
MAX8885EUK33	3.3	ADLH
MAX8885EUK50	5.0	ADLJ

Note: Other output voltages between 2.5V and 5.0V are available in 100mV increments—contact factory for information. Minimum order quantity is 25,000 units.

Pin Configuration

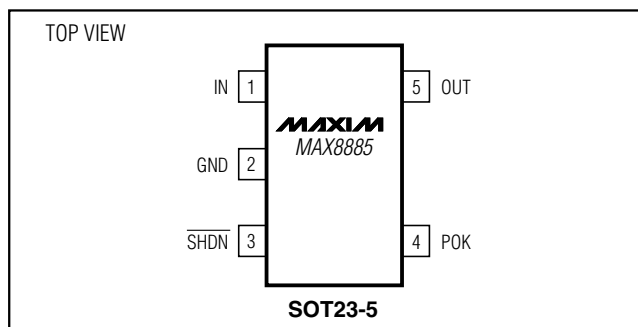

Features

- ◆ Optimized for Low-Cost Tantalum Capacitors
- ◆ Pin Compatible with MIC5206
- ◆ Undervoltage Power-OK Output
- ◆ Preset Output Voltages (±1% accuracy)
- ◆ Guaranteed 150mA Output Current
- ◆ 85µA No-Load Supply Current
- ◆ Low 110mV Dropout at 100mA Load (165mV at 150mA load)
- ◆ Thermal-Overload and Short-Circuit Protection
- ◆ Reverse-Battery Protection
- ◆ 60dB PSRR at 100Hz
- ◆ 1µA max Shutdown Current

Ordering Information

PART	TEMP. RANGE	PIN-PACKAGE
MAX8885EUK25	-40°C to +85°C	5 SOT23-5
MAX8885EUK27	-40°C to +85°C	5 SOT23-5
MAX8885EUK30	-40°C to +85°C	5 SOT23-5
MAX8885EUK33	-40°C to +85°C	5 SOT23-5
MAX8885EUK50	-40°C to +85°C	5 SOT23-5

Note: See Output Voltage Selector Guide for more information.

Typical Operating Circuit

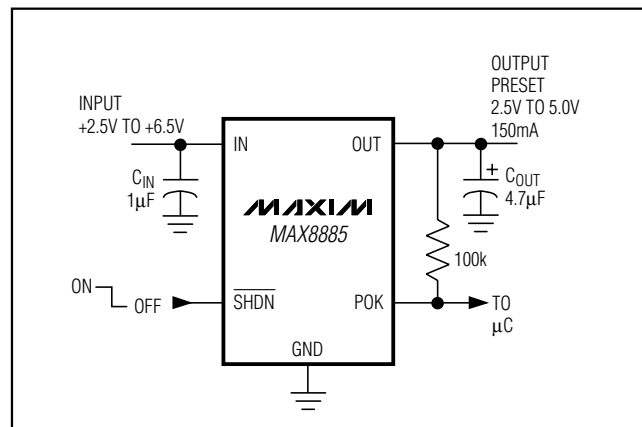

150mA, Low-Dropout Linear Regulator with Power-OK Output

ABSOLUTE MAXIMUM RATINGS

IN, $\overline{\text{SHDN}}$, POK to GND -7V to +7V
 $\overline{\text{SHDN}}$ to IN -7V to +0.3V
 OUT to GND -0.3V to ($V_{\text{IN}} + 0.3\text{V}$)
 Output Short-Circuit Duration Indefinite
 Continuous Power Dissipation ($T_A = +70^\circ\text{C}$)
 5-Pin SOT23 (derate 7.1mW/ $^\circ\text{C}$ above $+70^\circ\text{C}$) 571mW

Operating Temperature Range -40°C to $+85^\circ\text{C}$
 Junction Temperature $+150^\circ\text{C}$
 θ_{JA} $140^\circ\text{C}/\text{W}$
 Storage Temperature Range -65°C to $+150^\circ\text{C}$
 Lead Temperature (soldering, 10s) $+300^\circ\text{C}$

Stresses beyond those listed under "Absolute Maximum Ratings" may cause permanent damage to the device. These are stress ratings only, and functional operation of the device at these or any other conditions beyond those indicated in the operational sections of the specifications is not implied. Exposure to absolute maximum rating conditions for extended periods may affect device reliability.

ELECTRICAL CHARACTERISTICS

($V_{\text{IN}} = V_{\text{OUT(NOMINAL)}} + 1\text{V}$, $\overline{\text{SHDN}} = \text{IN}$, $T_A = -40^\circ\text{C}$ to $+85^\circ\text{C}$, unless otherwise noted. Typical values are at $T_A = +25^\circ\text{C}$.) (Note 1)

PARAMETER	SYMBOL	CONDITIONS	MIN	TYP	MAX	UNITS
Input Voltage	V_{IN}		2.5		6.5	V
Output Voltage Accuracy		$T_A = +25^\circ\text{C}$, $I_{\text{OUT}} = 100\mu\text{A}$	-1		1	%
		$T_A = -40^\circ\text{C}$ to $+85^\circ\text{C}$, $I_{\text{OUT}} = 100\mu\text{A}$	-2		2	
		$T_A = -40^\circ\text{C}$ to $+85^\circ\text{C}$, $I_{\text{OUT}} = 100\mu\text{A}$ to 120mA	-3		2	
Maximum Output Current	I_{OUT}		150			mA
Current Limit	I_{LIM}		160	390		mA
Ground Pin Current	I_{Q}	$I_{\text{OUT}} = 100\mu\text{A}$		85	180	μA
		$I_{\text{OUT}} = 150\text{mA}$		100		
Dropout Voltage (Note 2)	$V_{\text{IN}} - V_{\text{OUT}}$	$I_{\text{OUT}} = 100\mu\text{A}$		0.1		mV
		$I_{\text{OUT}} = 50\text{mA}$		50		
		$I_{\text{OUT}} = 100\text{mA}$		110	220	
		$I_{\text{OUT}} = 150\text{mA}$		165		
Line Regulation	ΔV_{LNR}	$V_{\text{IN}} = (V_{\text{OUT}} + 0.1\text{V})$ to 6.5V , $I_{\text{OUT}} = 1\text{mA}$	-0.15	0	0.15	%/V
Load Regulation	ΔV_{LDR}	$I_{\text{OUT}} = 100\mu\text{A}$ to 120mA , $C_{\text{OUT}} = 4.7\mu\text{F}$		0.01		%/mA
Output Voltage Noise		$C_{\text{OUT}} = 10\mu\text{F}$, $f = 10\text{Hz}$ to 100kHz		170		μVRMS
Output Voltage AC Power-Supply Rejection Ratio	PSRR	$f = 100\text{Hz}$		60		dB
SHUTDOWN						
Shutdown Supply Current	I_{OFF}	$\overline{\text{SHDN}} = \text{GND}$	$T_A = +25^\circ\text{C}$	0.005	1	μA
			$T_A = +85^\circ\text{C}$	0.02		
$\overline{\text{SHDN}}$ Input Threshold	V_{IH}	$V_{\text{IN}} = 2.5\text{V}$ to 5.5V		2.0		V
	V_{IL}				0.4	
$\overline{\text{SHDN}}$ Input Bias Current	$I_{\overline{\text{SHDN}}}$	$V_{\overline{\text{SHDN}}} = 5.5\text{V}$ or GND	$T_A = +25^\circ\text{C}$	0	100	nA
			$T_A = +85^\circ\text{C}$	0.05		

150mA, Low-Dropout Linear Regulator with Power-OK Output

ELECTRICAL CHARACTERISTICS (continued)

($V_{IN} = V_{OUT(NOMINAL)} + 1V$, $\overline{SHDN} = I_N$, $T_A = -40^{\circ}C$ to $+85^{\circ}C$, unless otherwise noted. Typical values are at $T_A = +25^{\circ}C$.) (Note 1)

PARAMETER	SYMBOL	CONDITIONS	MIN	TYP	MAX	UNITS
POWER-OK OUTPUT						
Power-OK Voltage Threshold	V_{POK}	$(1 - V_{OUT} / V_{OUT(NOMINAL)})100$, V_{OUT} falling, $I_{OUT} = 0$	-3	-5	-8	%
		In dropout, V_{OUT} falling		-5.3		
		Hysteresis, $I_{OUT} = 0$		1		
POK Output Voltage Low	V_{OL}	$I_{SINK} = 1mA$			0.4	V
POK Output Leakage Current		$0 \leq V_{POK} \leq 6.5V$, V_{OUT} in regulation			1	μA
THERMAL PROTECTION						
Thermal Shutdown Temperature	T_{SHDN}			170		$^{\circ}C$
Thermal Shutdown Hysteresis	ΔT_{SHDN}			20		$^{\circ}C$

Note 1: Limits are 100% production tested at $T_A = +25^{\circ}C$. Limits over the operating temperature range are guaranteed through correlation using Statistical Quality Control (SQC) methods.

Note 2: Dropout voltage is defined as $V_{IN} - V_{OUT}$, when V_{OUT} is 100mV below the value of V_{OUT} for $V_{IN} = V_{OUT} + 0.5V$.

Typical Operating Characteristics

(MAX8885EUK30, $V_{IN} = +3.6V$, $C_{IN} = 1\mu F$, $C_{OUT} = 4.7\mu F$, $\overline{SHDN} = I_N$, $T_A = +25^{\circ}C$, unless otherwise noted.)

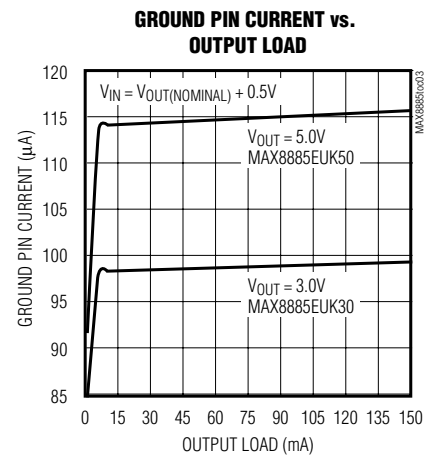
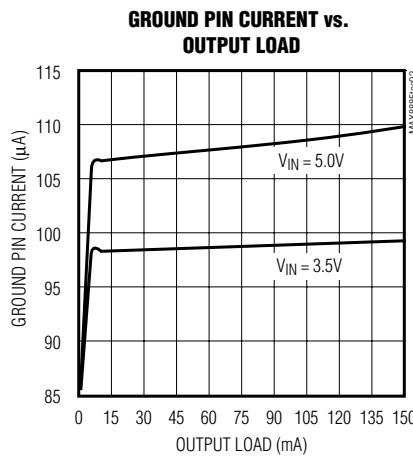
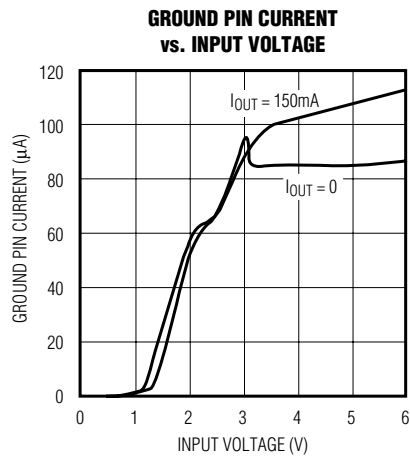

150mA, Low-Dropout Linear Regulator with Power-OK Output

Typical Operating Characteristics (continued)

(MAX8885EUK30, $V_{IN} = +3.6V$, $C_{IN} = 1\mu F$, $C_{OUT} = 4.7\mu F$, $SHDN = IN$, $T_A = +25^\circ C$, unless otherwise noted.)

GROUND PIN CURRENT vs. TEMPERATURE

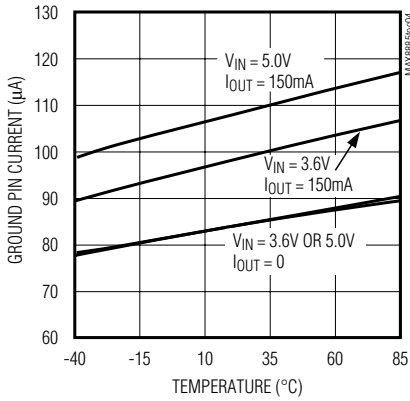

OUTPUT VOLTAGE vs. INPUT VOLTAGE

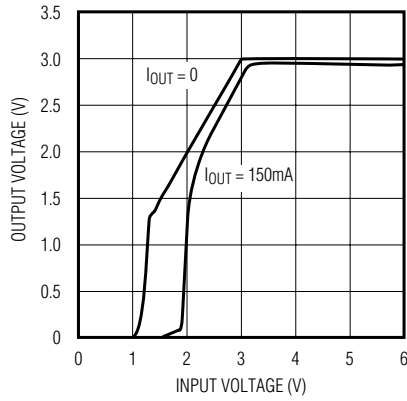

OUTPUT VOLTAGE vs. OUTPUT LOAD

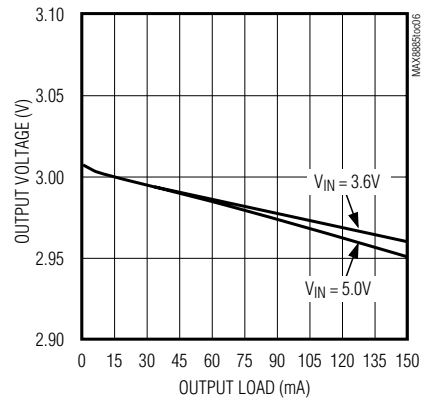

OUTPUT VOLTAGE vs. TEMPERATURE

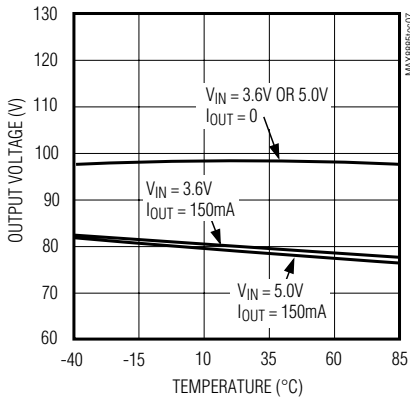

DROPOUT VOLTAGE vs. OUTPUT LOAD

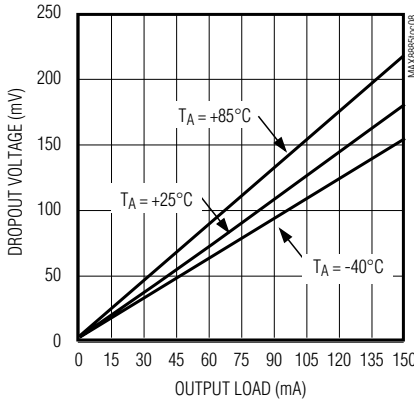

POWER-SUPPLY REJECTION RATIO vs. FREQUENCY

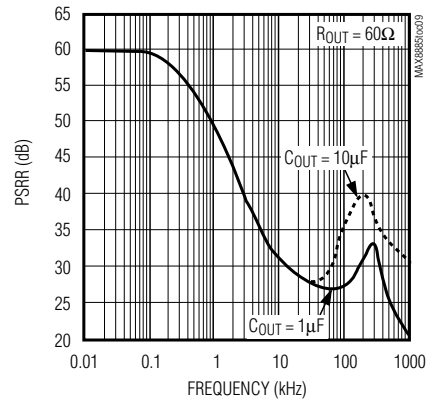

OUTPUT NOISE SPECTRAL DENSITY vs. FREQUENCY

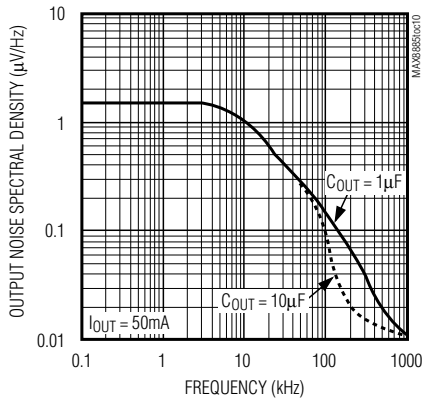

OUTPUT NOISE (10Hz TO 100kHz)

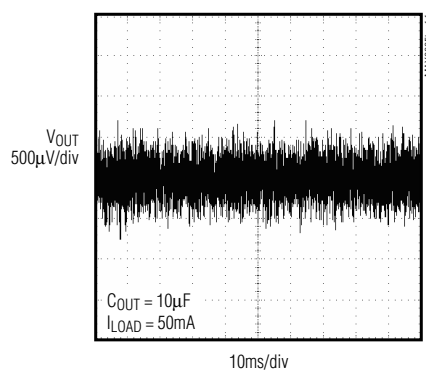

REGION OF STABLE C_OUT ESR vs. LOAD CURRENT

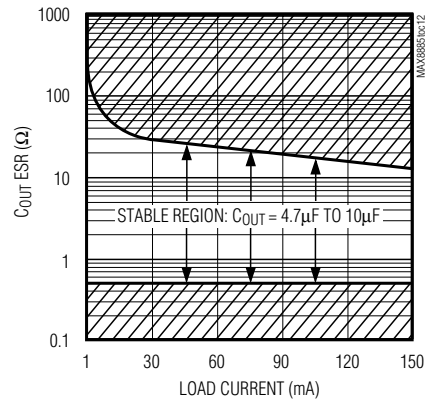

150mA, Low-Dropout Linear Regulator with Power-OK Output

MAX8885

Typical Operating Characteristics (continued)

(MAX8885EUK30, $V_{IN} = +3.6V$, $C_{IN} = 1\mu F$, $C_{OUT} = 4.7\mu F$, $SHDN = I_N$, $T_A = +25^\circ C$, unless otherwise noted.)

LINE-TRANSIENT RESPONSE

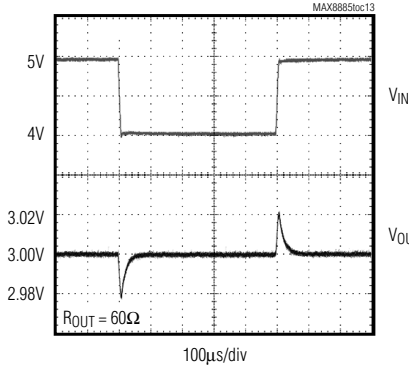

LOAD-TRANSIENT RESPONSE

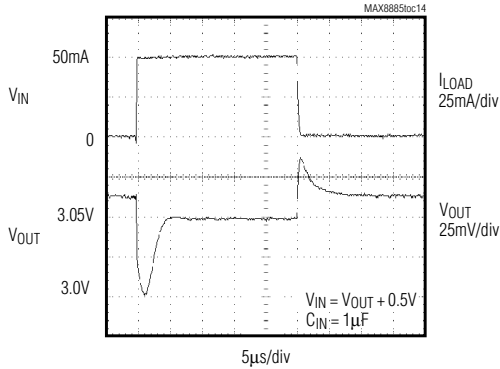

LOAD-TRANSIENT RESPONSE NEAR DROPOUT

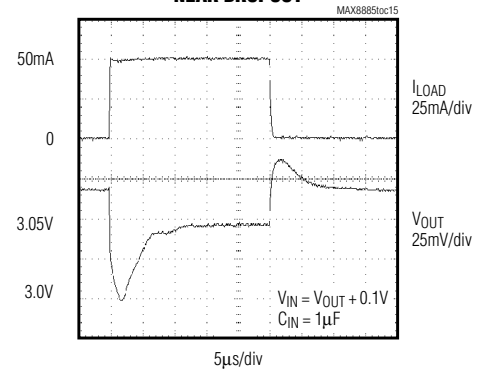

SHUTDOWN DELAY

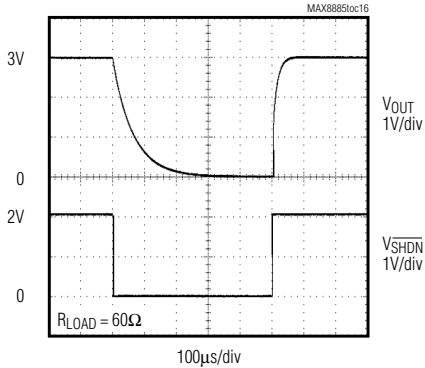

POK OUTPUT

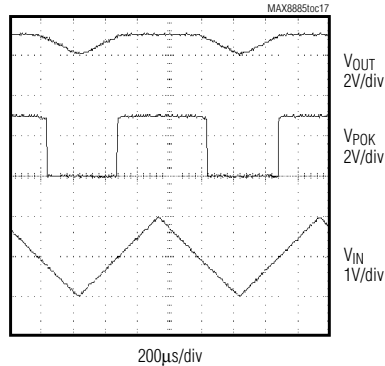

POK STARTUP RESPONSE

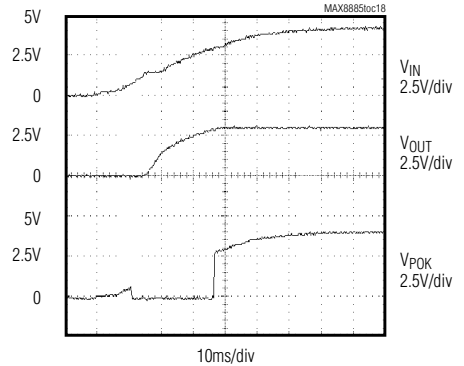

POK AND SHUTDOWN RESPONSE

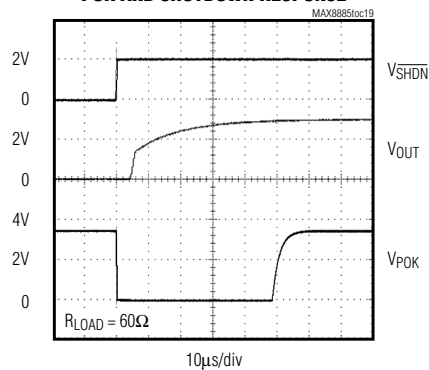

150mA, Low-Dropout Linear Regulator with Power-OK Output

Pin Description

PIN	NAME	FUNCTION
1	IN	Regulator Input. Supply voltage can range from +2.5V to +6.5V. Bypass with 1 μ F capacitor to GND (see <i>Capacitor Selection</i> and <i>Regulator Stability</i>).
2	GND	Ground. This pin also functions as a heatsink. Solder to a large pad or the circuit-board ground plane to maximize power dissipation.
3	$\overline{\text{SHDN}}$	Active-Low Shutdown Input. A logic low reduces the supply current to below 1 μ A. Connect to IN for normal operation.
4	POK	Power-OK Output. Active low, open-drain output indicates an out-of-regulation condition. Connect a 100k Ω pull-up resistor to OUT for logic levels. If not used, leave this pin unconnected.
5	OUT	Regulator Output. Fixed 5.0V, 3.3V, 3.0V, 2.7V, or 2.5V output. Sources up to 150mA. Bypass with 4.7 μ F (>0.5 Ω typ ESR) tantalum capacitor to GND.

Detailed Description

The MAX8885 is a low-dropout, low-quiescent-current linear regulator designed primarily for battery-powered applications using low-cost, high-ESR tantalum capacitors. The device delivers up to 150mA and is available with preset output voltages of 2.5V, 2.7V, 3.0V, 3.3V, or 5.0V. The MAX8885 consists of a 1.25V reference, error amplifier, P-channel pass transistor, power-OK comparator, and internal feedback voltage divider (Figure 1).

The 1.25V bandgap reference is connected to the error amplifier's inverting input. The error amplifier compares this reference with the feedback voltage and amplifies the difference. If the feedback voltage is lower than the reference voltage, the pass-transistor gate is pulled lower, which allows more current to pass to the output and increases the output voltage. If the feedback voltage is too high, the pass-transistor gate is pulled up, allowing less current to pass to the output. The output voltage is fed back through an internal resistor voltage divider connected to the OUT pin.

Additional blocks include a current limiter, reverse-battery protection, thermal sensor, and shutdown logic.

Output Voltage

The MAX8885 is supplied with factory-set output voltages of 2.5V, 2.7V, 3.0V, 3.3V, or 5.0V. The part number's two-digit suffix identifies the nominal output voltage. For example, the MAX8885EUK33 indicates a preset output voltage of 3.3V (see *Output Voltage Selector Guide*).

Internal P-Channel Pass Transistor

The MAX8885 features a 1.1 Ω (typ) P-channel MOSFET pass transistor. This provides several advantages over

similar designs using PNP pass transistors, including longer battery life. The P-channel MOSFET requires no base drive, which reduces quiescent current significantly. PNP-based regulators waste considerable current in dropout when the pass transistor saturates. They also use high base-drive currents under large loads. The MAX8885 does not suffer from these problems and consumes only 100 μ A of quiescent current whether in dropout, light-load, or heavy-load applications (see *Typical Operating Characteristics*).

Power-OK Output (POK)

When the output voltage goes out of regulation—as during dropout, current limit, or thermal shutdown—POK goes low. POK is an open-drain N-channel MOSFET. To obtain a logic-level output, connect a pull-up resistor from POK to OUT. To minimize current consumption, make this resistor as large as practical. A 100k Ω resistor works well for most applications. The POK function is not active during shutdown. A capacitor to GND may be added to generate a power-on-reset (POR) delay, which can operate down to $V_{IN} \leq 1V$. (See POK Startup Response in the *Typical Operating Circuit*.)

Current Limit

The MAX8885 includes a current limiter that monitors and controls the pass transistor's gate voltage, limiting the output current to 390mA (typ). For design purposes, consider the current limit to be 160mA (min) to 600mA (max). The output can be shorted to ground for an indefinite period of time without damaging the part.

Thermal-Overload Protection

When the junction temperature exceeds $T_J = +170^\circ\text{C}$, the thermal sensor signals the shutdown logic, turning off the pass transistor and allowing the IC to cool. The

150mA, Low-Dropout Linear Regulator with Power-OK Output

MAX8885

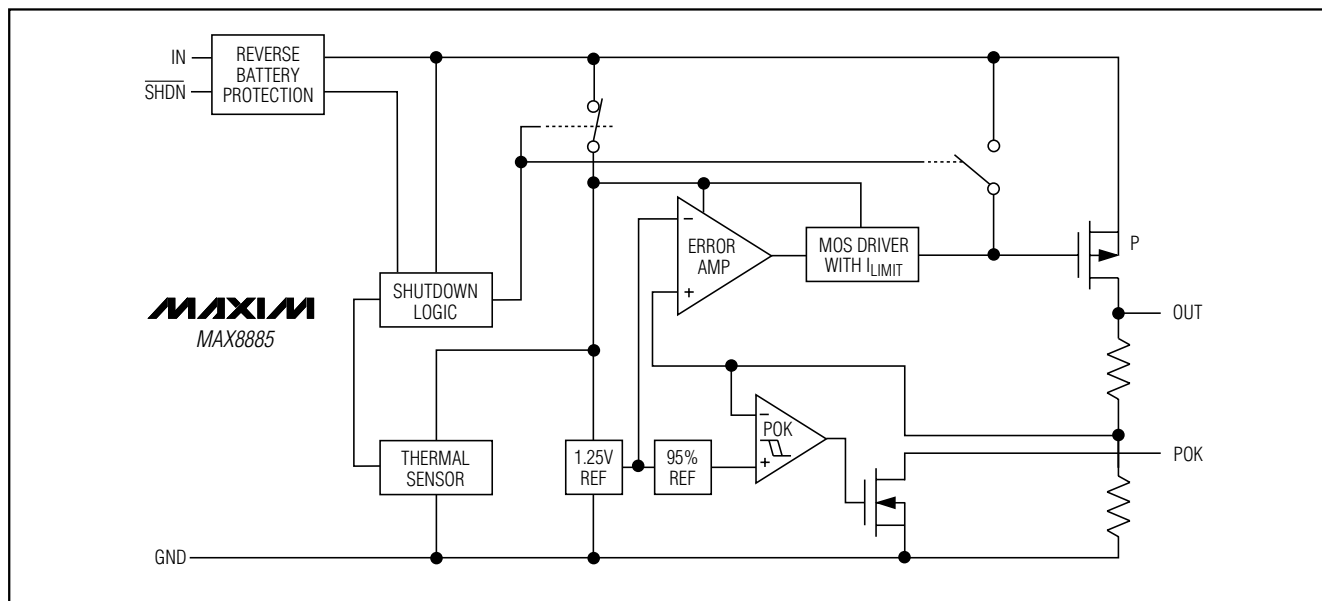

Figure 1. Functional Diagram

thermal sensor will turn the pass transistor on again after the IC's junction temperature cools by 20°C, resulting in a pulsed output during continuous thermal-overload conditions.

Thermal-overload protection is designed to protect the MAX8885 in the event of fault conditions. For continuous operation, do not exceed the absolute maximum junction-temperature rating of $T_J = +150^\circ\text{C}$.

Operating Region and Power Dissipation

The MAX8885's maximum power dissipation depends on the thermal resistance of the case and circuit board, the temperature difference between the die junction and ambient air, and the rate of air flow. The power dissipation across the device is $P = I_{OUT}(V_{IN} - V_{OUT})$. The maximum power dissipation is:

$$P_{MAX} = (T_J - T_A) / (\theta_{JB} + \theta_{BA})$$

where $T_J - T_A$ is the temperature difference between the MAX8885 die junction and the surrounding air; θ_{JB} (or θ_{JC}) is the thermal resistance of the package; and θ_{BA} is the thermal resistance through the printed circuit board, copper traces, and other materials to the surrounding air.

The MAX8885's GND pin performs the dual function of providing an electrical connection to system ground and channeling heat away. Connect GND to the system ground using a large pad or ground plane.

Reverse-Battery Protection

The MAX8885 has a unique protection scheme that limits the reverse supply current to 1mA when either V_{IN} or V_{SHDN} falls below ground. The circuitry monitors the polarity of these two pins and disconnects the internal circuitry and parasitic diodes when the battery is reversed. This feature prevents device damage.

Applications Information

Capacitor Selection and Regulator Stability

The MAX8885 is designed primarily for applications using low-cost, high-ESR output capacitors such as small case-size tantalum electrolytic capacitors. These capacitors have ESR that can extend as high as 10Ω, and their capacitance and ESR can vary widely over their operating temperature range. For stable operation over the full operating range, use a 4.7μF (1μF min) capacitor with $ESR > 0.5\Omega$ (see the Region of Stable C_{OUT} ESR vs. Load Current graph in the *Typical Operating Characteristics*). Ceramic output capacitors should not be used with the MAX8885. For a pin-compatible, functionally equivalent linear regulator that is suitable for ceramic output capacitors, refer to the MAX8875 data sheet.

Bypass the MAX8885's input with a 1μF or greater capacitor to GND. Place this capacitor close to the device (<5mm).

150mA, Low-Dropout Linear Regulator with Power-OK Output

PSRR and Operation from Sources Other than Batteries

The MAX8885 is designed to allow low dropout voltages and low quiescent currents in battery-powered systems. Power-supply rejection is 60dB at low frequencies (see the Power-Supply Rejection Ratio vs. Frequency graph in the *Typical Operating Characteristics*).

Improve supply-noise rejection and transient response by increasing the values of the input and output bypass capacitors. The typical operating characteristics show the MAX8885's line- and load-transient responses.

Load-Transient Considerations

The MAX8885's load-transient response graphs (see *Typical Operating Characteristics*) show three components of the output response. The first (and most significant) component is the abrupt drop in output voltage due to the capacitor's ESR. The magnitude of the voltage drop is directly proportional to the output capacitor's ESR and the size of the load transient and is independent of the regulator's transient response. The second component is the output voltage recovery, which is a function of the regulator's loop response and the capacitance at the output. The third component is a DC shift in the output voltage resulting from the regulator's finite output impedance. To improve the MAX8885's load-transient response, increase the output capacitor's value and decrease its ESR. Take care to ensure that the out-

put capacitor is chosen to comply with the Region of Stable C_{OUT} ESR vs. Load Current graph.

Dropout Voltage

A regulator's minimum input-output voltage differential (or dropout voltage) determines the lowest usable supply voltage. In battery-powered systems, this will determine the useful end-of-life battery voltage. Because the MAX8885 uses a P-channel MOSFET pass transistor, its dropout voltage is a function of drain-to-source on-resistance ($R_{DS(ON)}$) multiplied by the load current (see *Typical Operating Characteristics*).

$$V_{DROPOUT} = V_{IN} - V_{OUT} = R_{DS(ON)} \cdot I_{OUT}$$

Chip Information

TRANSISTOR COUNT: 266

Package Information

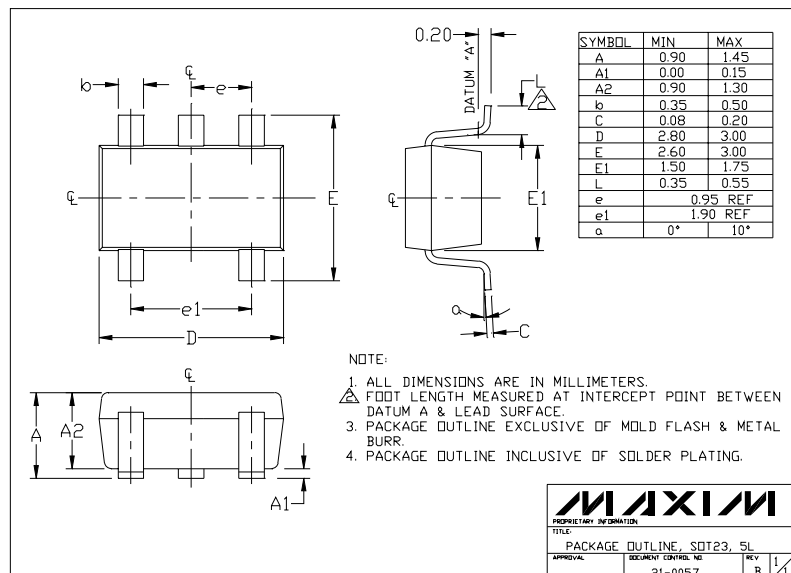

Maxim cannot assume responsibility for use of any circuitry other than circuitry entirely embodied in a Maxim product. No circuit patent licenses are implied. Maxim reserves the right to change the circuitry and specifications without notice at any time.

8 Maxim Integrated Products, 120 San Gabriel Drive, Sunnyvale, CA 94086 408-737-7600